



FY-40A Flight Stabilization System

Installation & Operation Manual

Dear Customers,

Thank for choosing FY-40A as your inertial stabilization solution. Please read this manual carefully before using the system to ensure proper use and operation. If you need any technical support kindly contact us directly: service@feiyu-tech.com.

1、 Operating Principle And Function

FY-40A has an integrated three-axis gyro and three-axis accelerometer which controls the aircraft movement in three-dimensional space. By using your remote control, the unit can be turned on or off for the following functions:

- **Mode 1: FY-40A Deactivated Mode** In this mode, the FY-40A stabilization function is turned off. The aircraft is completely under the control of the pilot.
- **Mode 2: Auto Stabilization Mode** In this mode, the FY-40A will automatically command the aircraft control surfaces to maintain level flight at all times.
- **Mode 3: 3D Control Mode** In this mode, the balancer utilizes its 3-axis gyroscope to sense roll velocity and flight attitude. If no input is given by the pilot (sticks in the middle position) the FY-40A will lock the current aircraft attitude. This prevents rolling of the aircraft at the axial plane and maintains its current posture. Therefore the aircraft can be easily maneuvered to complete a variety of 3D flight with added stability and smoothness.

2、 Technical Specification And Working Requirement

- Input Voltage : 4.0 ~ 6.0 Volt;
- Current Draw : 50mA (5V);
- Size : 45mm x 30mm x 9 mm;
- Weight (Excluding Wires) : 17g;
- Temperature Range : -25 ° C ~ +70 ° C;
- Maximum Rate Of Rotation : ≤ 2000 °/s;

3、 Aircraft Suitability

- Traditional layout fixed-wing aircraft
- Flying wings with rudder
- Flying wings with no rudder
- Airplanes with no ailerons (rudder and elevator only)
- V-tail airplanes with aileron and with no ailerons

4、 Standard Configuration

- FY-40A control module * 1
- RC receiver connecting wires * 1
- Velcro double sided tape * 2
- Instruction manual * 1
- Gyro sensitivity adjustment screwdriver* 1

5、 Connection Diagram

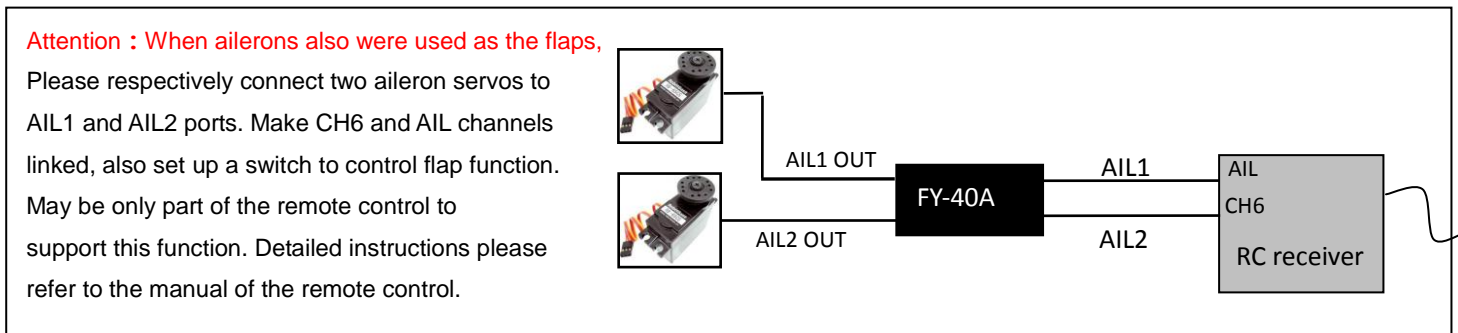
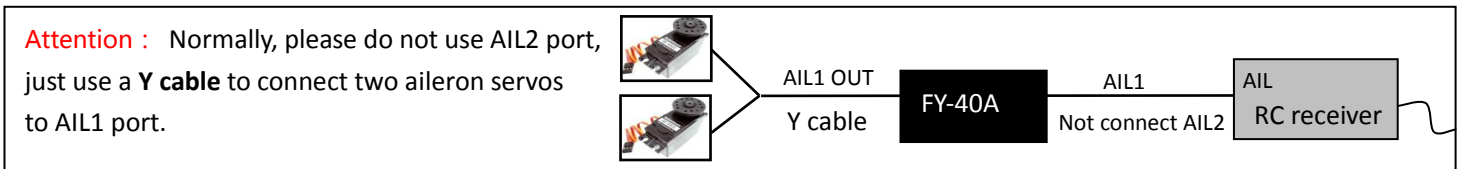
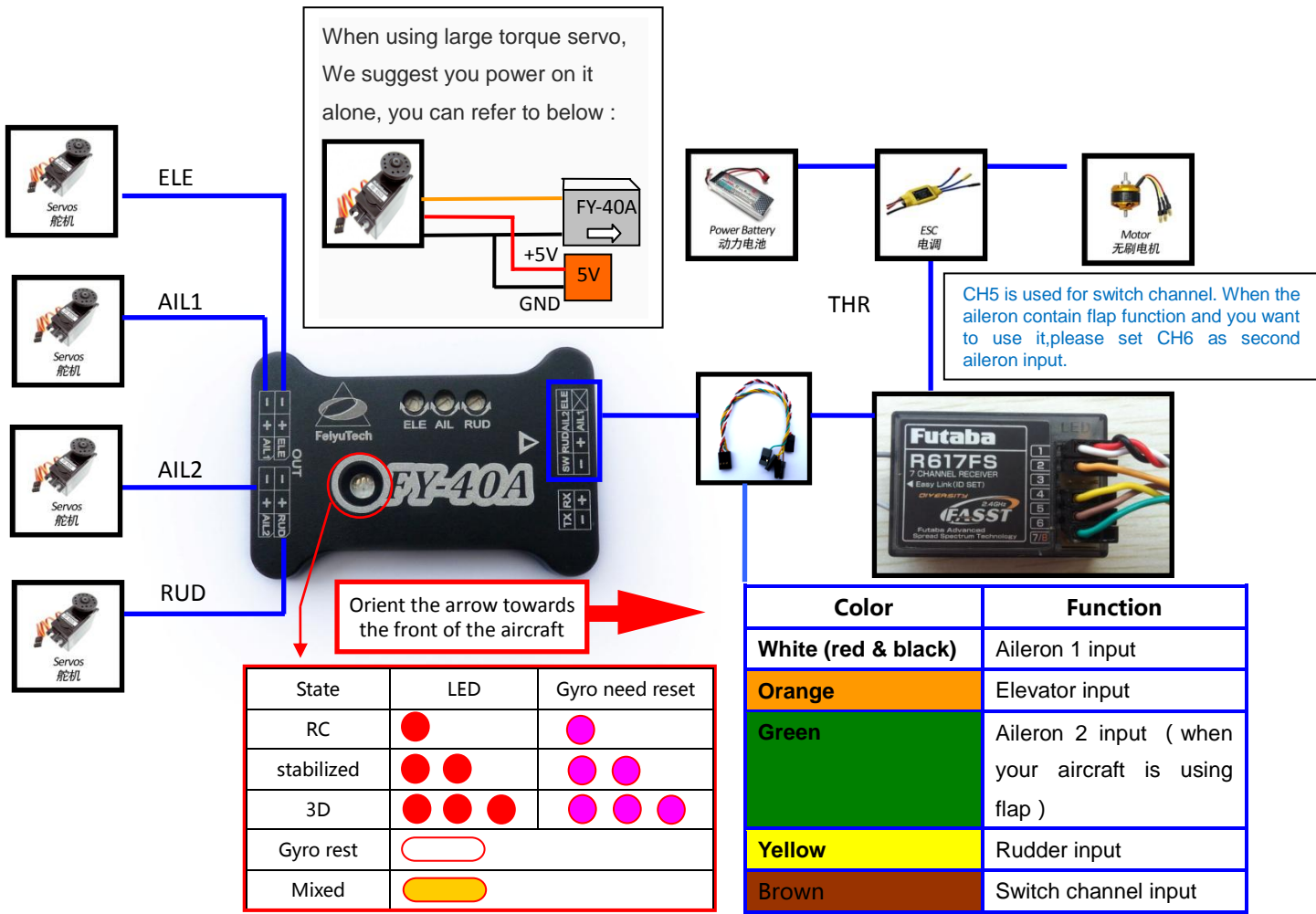



6、 Servo Interface Connection Instructions

Interface	Traditional	Flying wing (Aileron & Elevator mixed control servo)	V tail (Elevator & Rudder mixed control)	Airplanes with no ailerons
ELE	Elevator servo	Mixed control servo 1	Mixed control servo 1	Elevator servo
AIL1	Aileron servo 1	Mixed control servo 2	Aileron servo 1	Rudder servo
RUD	Rudder servo	Rudder servo	Mixed control servo 2	
AIL2	Aileron servo 2 (when using flap function)		Aileron servo 2 (when using flap function)	

7、 Switch Setting For FY-40A Flight Modes

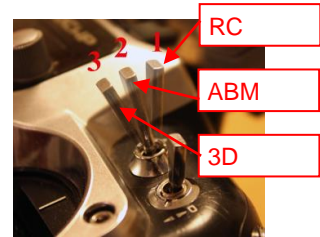
FY-40A requires a minimum of 5-channel RC receiver. 4 Receiver channels are used for aileron (channel 1), elevator (channel 2), throttle (channel 3) and rudder (channel 4) signal output. 1 free Receiver channels are required to control the FY-40A Flight Modes (a 3-position switch or dial knob, "SW"). If you do not connect SW, FY-40A will work on "ABM" mode.



Receiver signal output 	900~1200US	1200~1800US	1800~2100US
Work Mode	RC	ABM	3D
LED	●	● ●	● ● ●

8、 Setting The Mixing Control Mode

First, you should set the remote control is the fixed-wing aircraft conventional layout mode, do not set any mixing control. FY-40A can be achieved "Aileron & Elevator mix control" and "Elevator & Rudder mix control", you can through SW to set it. On SW, within 10 seconds from the "Auto Stabilization mode" → "3D mode" → "Auto Stabilization mode" **repeatedly fast** switch six

times, You will see the light flashes yellow. After **YellowLED** turns off, the mixing control mode Setting is completed.

The mixed control setting will cycle changes like picture below shows:

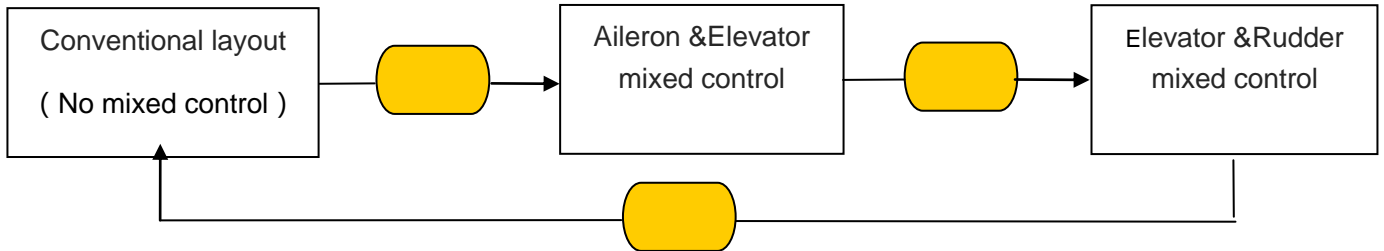

9、 Gyroscope Reset

FY-40A has motion detection function, if it's moving, work mode indicator red LED will become purple. But if the indicator LED still purple even when the FY-40A remains stationary, that means you need to do the Gyro reset.

Initialization / Reset Process:

- (1) Power on FY-40A and keep stationary.
- (2) Switch to Auto stabilization mode.
- (3) On SW, switch Auto stabilization mode to Deactivated mode 6 times, time interval has to be less than 3 seconds as follows:

Auto stabilization mode → Deactivated mode → Auto stabilization mode → Deactivated mode → Auto stabilization mode → Deactivated mode → Auto stabilization mode → Deactivated mode → Auto stabilization mode → Deactivated mode → Auto stabilization mode → Deactivated mode.

- (4) FY-40A indicator will turn white about one second.
- (5) After white LED turns off, the re-setting / initialization is completed.

10、 Adjustment Dials For ELE, AIL And RUD

(1) There are 3 adjustment dials on the FY-40A. Each dial controls both gyro gain and servo direction during auto stabilization.

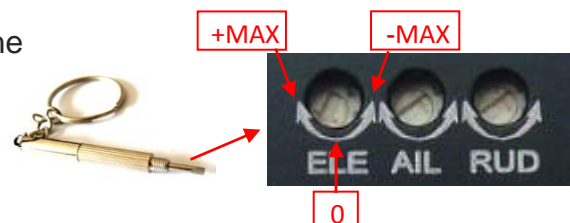

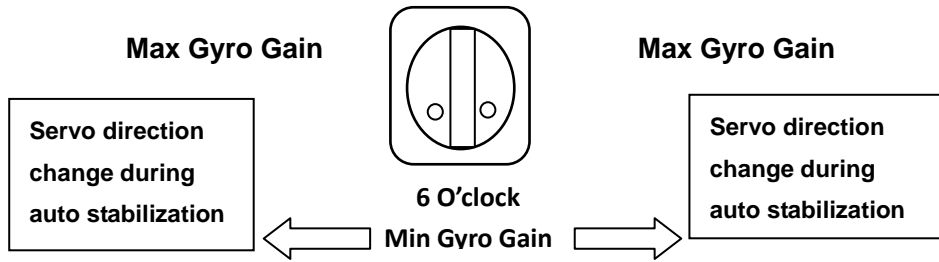

(2) Gyro Gain: The further away from Centre (6 O'clock) the higher the Gyro gain (sensitivity). Too low gain result is poor auto stabilization, too high gain will cause oscillations of the aircraft. You need to adjust the gain setting based on the requirement of your aircraft.

(3) Servo Direction: The dials also control the direction of your servo movement. Turning it clockwise or counter clockwise from 6 O'clock will change the direction of your servos during tilting, roll and yaw movement.

Switch to the "**Auto Balance Mode**" mode, check the auto control movement direction as explained below:

11、Aileron Servo Auto Movement Check

- RIGHT Roll the plane & the right aileron should automatically move downwards, while the left aileron moves up.
- LEFT Roll the plane & the left aileron should automatically move downwards, while the right aileron should move up.
- If the servo movement is incorrect, you need to reverse the automated servo movement via the AIL dial.

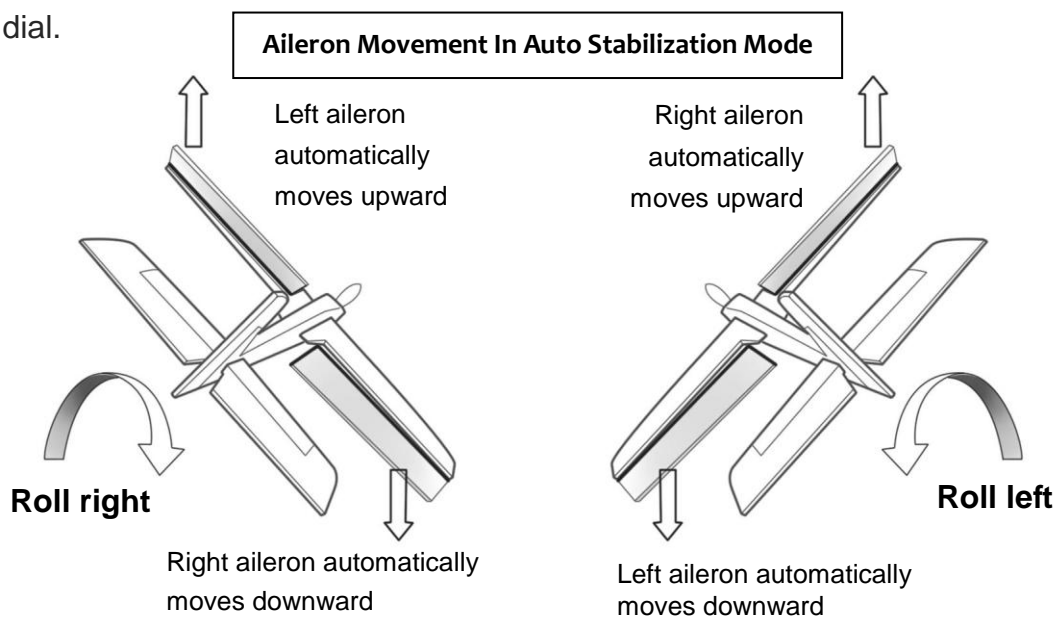

12、 Elevator Servo Auto Movement Check

- UPWARD Incline the plane nose & the elevator should automatically move downwards.
- DOWNWARD incline the nose & elevator should automatically move upwards.
- Servo movement is incorrect, reverse it via the ELE dial.

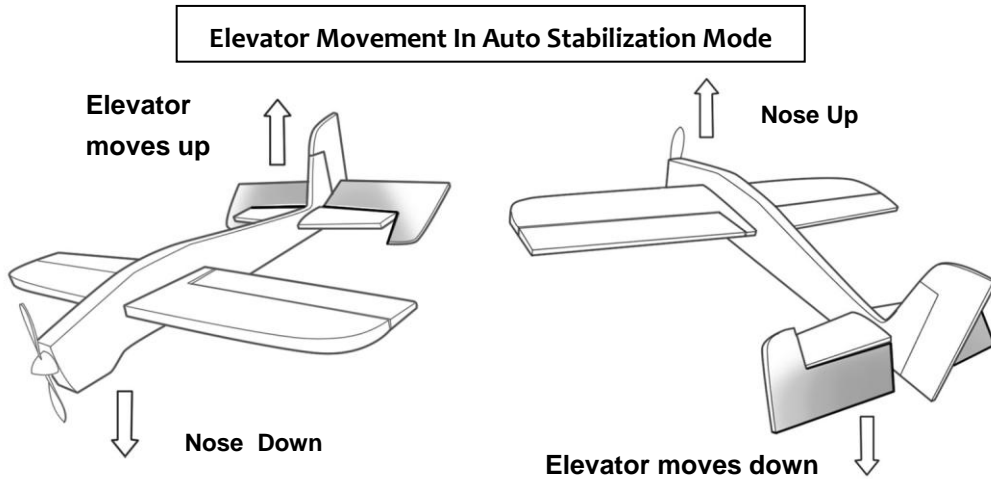

13、 Rudder Servo Auto Movement Check

- CLOCKWISE rotate your plane & the rudder should move to the Left.
- COUNTER CLOCKWISE rotation & the rudder should move to the Right
- Servo movement is incorrect, reverse it via the RUD dial.

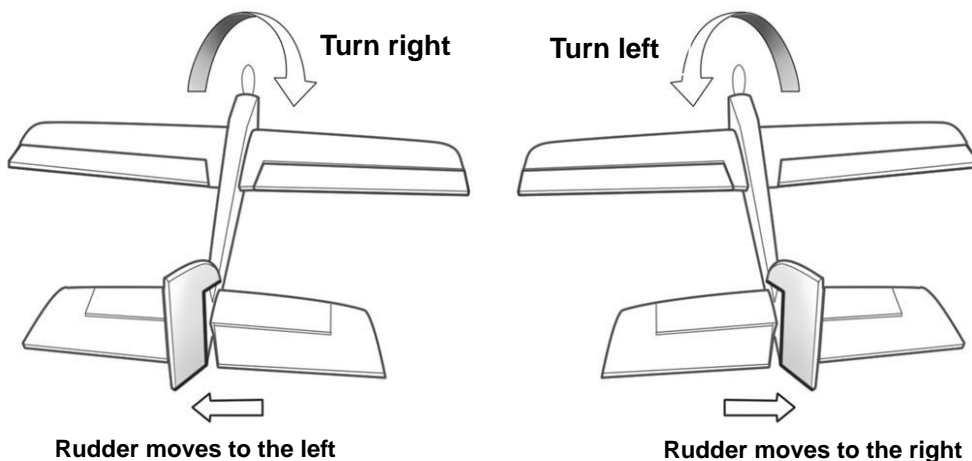

14、 Other Considerations

Damping Installation: FY-40A is vibration-sensitive. To optimize its stabilization capability, vibrations reaching the unit must be kept at a minimum. Good damping installation is the basis of

FY-40A can do normal work, also can decide whether FY-40A to maximize play flight performance or not, and make sure you have a great flight, otherwise may cause serious flight accidents. You can use your own DIY shock absorbing devices to do the shock absorbing, but we recommend using suspending damping installation.

3D Mode: If no input is given by the pilot (all sticks in the middle position), 3D mode will lock the current aircraft attitude. Therefore the aircraft can be easily maneuvered to complete a variety of 3D flight with added stability & smoothness.

Attention: Please make sure the RC stick is released when you switch into 3D Mode. The FY-40A can record current RC stick position and lock the flight attitude when your RC stick released.

In Auto Stabilized Mode: At Activated Mode can be straight and level flight, stick sw1 to Stabilized Mode, if the airplane is not level flight, for example, it drive to down, you can adjust angle of installation prevent plane down, this time can change the FY-40A pitch, example, the rear pad FY-40A high.

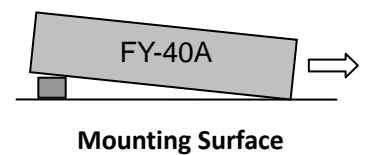

Gyro sensitivity adjustment: Please do not use very high sensitivity during your first flight in order to avoid control shock which cause by FY-40A give too much auto control movement to your aircraft.. Please take off and switch in to Auto Stabilization mode. Manually to change the plane roll and pitch, etc., to observe the plane automatic balance situation. If recover to balance is too quick, don't feel flexible operation you can reduce corresponding channel control gain; If the pitch, roll and orientation rapid shaking, or flight speed increases appear sloshing, you need reduce corresponding control channel gain; If recover to balance is too slow, the poor control ability is require you to increase control gain.

Safety Measures: Balancing instrument is designed to keep flying balance. It can not control the aircraft or prevent stalling. You must control the flight direction of the aircraft, and make sure yourself know that where the airplanes fly. The balancing instrument only use for entertainment. Please don't install to the aerial photography aircraft that likely flew over the crowd. Any electronic product and equipment on the Machine can not be completely reliable, Before you use FY-40A Airplane balancing instrument, you should make a assess for the product, Our company don't liable for any damage caused by using the product and the consequences. Our company do not responsible for any losses and effects of using the product.

—— END ——

Note: We reserve the right to change this manual at any time! And the newest edition will be shown on our website www.feiyudz.cn.