



DoS Flight Stabilization System

Installation & Operation Manual V1.1

Dear Customer:

Thank you for choosing DoS as your autopilot system. Please read this manual carefully before using the system to ensure proper use and operation.

The installation and use of this device require some skill and knowledge in flying remote controlled fixed wing aircraft.

- If you are a complete beginner and have never flown one before, we do not recommend you install this device on your own.
- Please find assistance from an experienced RC pilot who may provide you with the basic knowledge required to use this device successfully.
- If you are already an experienced flyer, you will find the DoS installation to be easy and logical. Just follow this manual and you won't go wrong.

If you need any technical support you can send e-mail directly to: service@feiyu-tech.com

1. Operating principle :

Attitude Flight Stabilization System (AFSS)

DoS module

DoS is an inertial attitude measurement instrument. Now version V1.1 used for automated stabilization of fixed wing model aircrafts, but after upgrade firmware can be used for other aircraft and equipment control (For more details of DoS, please refer to the latest firmware and instructions)

DoS has integrated three-axis gyro, three-axis accelerometer, three axis magnetometer and barometric pressure sensor. DoS can accurately measuring flight attitude, the earth azimuth and through the barometer to measure relative altitude. Through the sensor measurement data combined with attitude control can realize the Stabilized Mode, 3D Mode, Return To Launch Mode, Fixed altitude and Heading lock flight Mode, Auto Circling Mode and so on.

GPS module

GPS module enables the DoS to calculate the flight course and exact location of the aircraft. DoS has three navigation mode :Return To Launch, Auto Circling and Heading lock, You can activate any of navigation modes after connecting GPS.

Altitude control

DoS use the barometer to measure relative height, through the elevator servo and throttle control to realize the flying altitude control.

Heading control

Without GPS module, DoS through the three axis magnetometer to measure the heading angle, use the aileron servo and rudder servo to control flying heading. But will be affected by the wind then deviate from the original route.

After connecting the GPS, DoS receives position and course information to keep straight flying. And DoS will automatically correct the deviation cause by crosswind.

Speed control

The DoS has some control over the throttle channel after connect GPS module. When flying in Navigation mode, please ensure the throttle stick control signal is enough. Otherwise you aircraft maybe stall.

2. Function of DoS

The function of DoS without GPS

● **Deactivated Mode**- In this mode, the DoS stabilization turned off. The aircraft is completely under the control of the pilot.

● **Stabilized Mode** - DoS can automatically keep the level flight attitude in any weather condition. This makes operating the aircraft become very simple and easy for the beginner. When the pilots feel the plane out of control as long as stabilize the flight throttle, loosen the operating sticks, it can automatically recover to the level state.

●**3D Mode** - In this mode,if no input is given by the pilot(sticks in the middle position) the DoS will lock the current aircraft attitude.Therefore the aircraft can be easily maneuvered to complete a variety of 3D flight with added stability and smoothness.

●**Fixed altitude and Heading lock flight Mode** - can lock the flight course and maintain the flight height. Loosen the operating stick; the plane can automatically keep flight course, at the same time lock flying height, automatically correct flight course deviation, easy to operate.

●**Auto Circling Mode** -Plane will keep the current height, at a certain turn rate hovering flight (look up, a counterclockwise circle), but it will not hover around a fixed point, and may be away from the original hovering point because of the wind.

The function of DoS with GPS

●**Fixed altitude and Heading lock flight Mode** - Can lock the flight course and maintain the flight height. Loosen the operating sticks; plane can automatically keep flight course, at the same time lock flying height, automatically correct flight course deviation, and begin straight line flight. Easy to operate

●**Auto Return To Launch Mode(RTH)** - In the Auto Return To Launch Mode, aerobat will automatically return to the course reversal point, keeping the current height, and it will hover after arriving the target point.

●**Auto Circling Mode**-When activated in this mode, the plane will immediately fly in a circle(look up , clockwise hovering). The centre of the circle is the point of activation.The plane will hover keeping the current height, The hovering radius can be set, and the default circle radius is 80 meters.

●**GCS software** –Operator can set flight parameters, monitoring and recording flight path etc through the GCS software in the computer.(This requires connecting the data radio) .

DoS can connect with the Hornet-OSD and the Data Radio

DoS has one UART interface for connecting the FY-data radio and the OSD module. It can realize the following function by combing them.

●**First Person View (FPV)**: Can be connected to the Hornet - OSD, the flight data stack to video output,and through the vodo transmission system to send back, let you enjoy the fun of FPV. And it will be easier to operate FPV with the functions of automatic balance, Fixed altitude and Heading lock flight and Auto Return To Launch.

●**Real time telemetry**-real time monitor the flying state, using the Data Radio to lengthen the remote control distance , and you can change the flight height and flight parameter through the Ground control system(GCS).

For more information, please refer to the FY-OSD and FY Data Radio manual.

3. DoS standard configuration

Standard configuration

- DoS control module *1;
- RC receiver connecting wires * 1;
- USB cable *1;
- 4P Y cable*1;
- Velcro double sided tape * 2;
- Instruction manual * 1;

Optional accessory

- GPS module *1;
- Hornet OSD module;
- Data Radio;
- Remote Adaptor;

4. Technical Specification and working requirement

DoS module

Input voltage : 4.0 ~ 6.0 Volt;

Current draw : 50mA (5V);
 Size : 47 x 30 x 11 mm;
 Weight (excluding wires) : 25g;
 Temperature range : -25 °C ~ +70 °C;
 Maximum rate of rotation : ≤ 2000 °/s

GPS module

Input voltage : 3.0 ~ 3.3 Volt;
 Current draw : 60mA (3.3V);
 Size : 32 x32x 10 mm;
 Weight (excluding wires) : 22g;
 Temperature range : -25 °C ~ +70 °C;

The DoS can be installed in the following aircraft

- 1, Normal / Traditional fixed-wing planes;
- 2, Delta-winged plane with rudder;
- 3, Delta-winged plane without rudder;
- 4, Plane without aileron;
- 5, V-tail plane with aileron;
- 6, V-tail plane without aileron;
- 7, Any other configuration, please e-mail us for enquiry: service@feiyu-tech.com

The DoS has been tested to work with the following RC systems

- Robbe-Futaba PPM / PCM 1024 / PCM G3 mode, 2.4 GHz systems ;
- Graupner/JR PPM 8, PPM 12, SPCM mode ;
- MPX PPM8, PPM 12 with UNI mode
- Any remote control system using the standard of 1.5 ms neutral value.

5. DoS interface

Remote receiver input interface

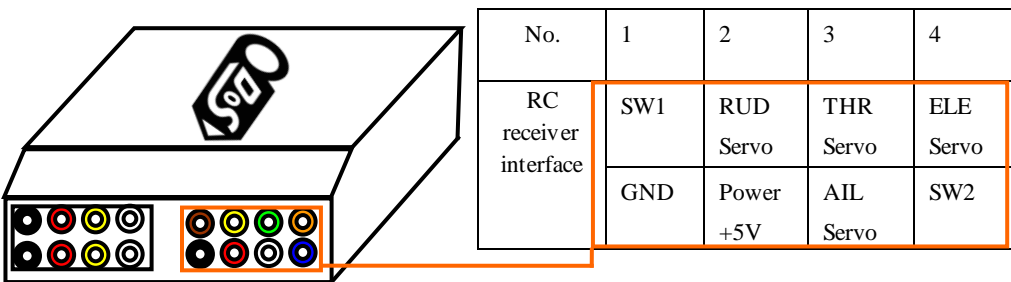

GPS and UART interface

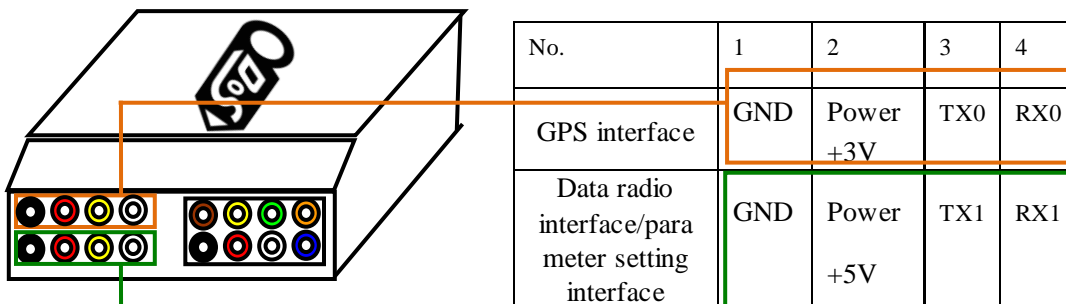

GPS module interface

The GPS pin interface consist of: GND, +3V , RX0. The characteristics are:

Baud rate: 38400

Data bits: 8

Stop Bits: 1

Parity: None

Interface Features: TTL level

Connect the above to the GPS Receiver. The GPS data protocol is a standard NEMA0183 and the statement must be \$ GPRMC, \$ GPGGA.

TXO pin interface is used to output DoS data, and connect Hornet-OSD(V1.6 edition).

Data Radio interface

The UART pin interfaces consist of: GND, power 5V , TX1, RX1. The characteristics are as follow:

Baud Rate: 19200

Data bits: 8

Stop Bits: 1

Parity: None

Interface Features: TTL level

The pin interfaces connects to the Data Radio, PC computer serial port or OSD module. You can set DoS control parameters through this interface. The port is also used to upgrade DoS firmware. Please read the procedure for the firmware upgrade.

Servo output interface

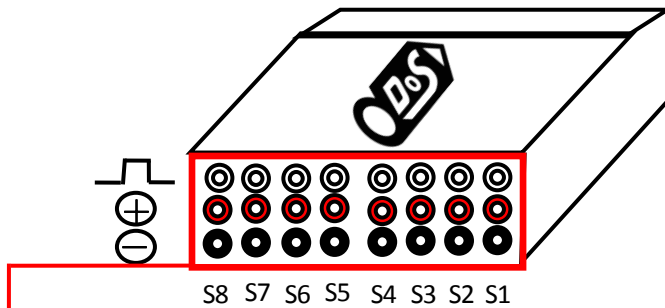

No.	S8	S7	S6	S5	S4	S3	S2	S1
Servo Output Interface	P2	P1	N	AIL2	RUD	THR	ELE	AIL
	Power	Power	Power	Power	Power	Power	Power	Power
	+5V	+5V	+5V	+5V	+5V	+5V	+5V	+5V
	GND	GND	GND	GND	GND	GND	GND	GND

V1.1 firmware servo output introduction

S1: connection aileron servo 1(same signal as S5).

S2: connection elevator servo.

S3: connection ESC or throttle servo.

S4: connection rudder servo.

S5: connection aileron servo 2 (without setting mix control ,same signal as S1)

S6: not used

S7:When use Remote Adaptor, CH7 receiver output channel (detail please reference Remote Adaptor and Data Radio introduction)

S8: When use Remote Adaptor, CH8 receiver output channel (detail please reference Remote Adaptor and Data Radio introduction)

Plane connecting layout

1)connection for traditional aircraft layout:

S1	S2	S3	S4	S5
Aileron servo 1	Elevator servo	ESC/throttle servo	Rudder servo	Aileron servo 2

2)connection for flying wing aircraft(with or without Rudder)

S1	S2	S3	S4
Differential Servo 1	Differential Servo 2	ESC/throttle servo	Rudder servo

3)connection for V tail aircraft with Aileron

S1	S2	S3	S4	S5
Aileron servo 1	Differential Servo 1	ESC/throttle servo	Differential Servo 2	Aileron servo 2

4) connection for V tail aircraft without ailerons:

S1	S2	S3	S4
Differential Servo 1	Differential Servo 2	throttle servo	NULL

6. Power supply

- DoS input voltage is 4.0 ~ 6.0 V.
- DoS is powered via the RC receiver connection wires,the same power as RC receiver.
- If your plane is electric powered, the RC receiver power supply is normally from the ESC built-in Battery Elimination Circuit (BEC). However, we highly recommend that a separate BEC with a +5V output.
- For Gas or Nitro powered planes, you will require a battery to power the RC receiver and DoS .

7. RC receiver connection

RC receiver and DoS connection wires is included in the DoS product. Attention: the wires is arranged by the colors.



- DoS requires a minimum of 6-channel RC receiver.
- 4 Receiver channels are used for aileron (channel 1), elevator (channel 2) ,throttle (channel 3) and rudder (channel 4) signal output. Connect these 4 receiver output signals to the DoS with the supplied wires (pay attention to the color of each channel).
- 2 free Receiver channels are required to control the DoS Flight Modes (a 3-position switch or dial knob, "SW1") and Autopilot Mode (a 3-position switch or dial knob, "SW2").

Wire color	Receive channel	
White (bundled with red & black)	aileron	Channel 1
orange	elevator	Channel 2
green	throttle	Channel 3
yellow	rudder	Channel 4
brown	SW 1 Any free channel controlled by A 3-way switch or dial knob	Channel 5
blue	SW 2	Channel 6

	Any free channel controlled by A 3-way switch or dial knob	
--	---	--

8. GPS interface and Features

- a. Install the GPS Module with the antenna face up (see following picture). DO NOT install next to metal or carbon fiber and other shielding material, which may block satellite signal.
- b. Install the GPS Module away from electromagnetic sources such as ESC's, power wires, servo wires and video transmitters.



color	Black	red	white
function	GND	3V	GPS Data

9. Connection of DoS

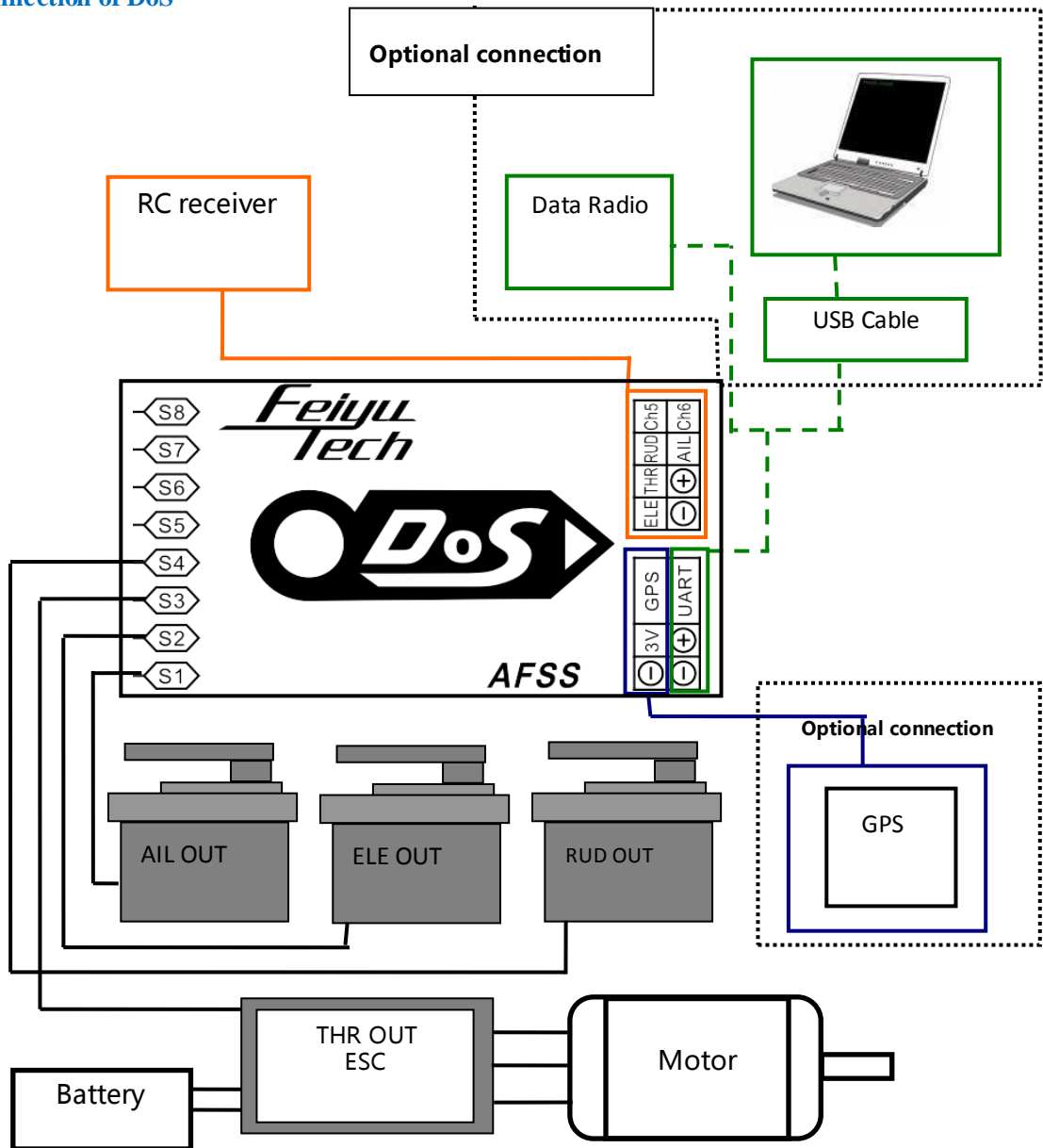

10. DoS indicator light instruction

DoS with three colors LED which can send out red, blue, green light. Also yellow, white, purple and other colors light through the combination.

Operators can know the DoS's operating mode by judging the different colors which the LED sends out and the flash frequency : green light flash means GPS location fixed, red and blue light indicate DoS working mode. Under manual mode, stabilization mode or 3D mode, keep DoS in the static state. If it sends out purple light it means DoS needs Gyro Reset.

NO.	operating mode	LED	Gyro needs Reset or is moving	GPS location fixed (4 satellites or more)
1	manual mode	●	●	●
2	stabilized mode	● ●	● ●	●
3	3D mode	● ● ●	● ● ●	●
4	Auto Return To Launch Mode	●		●
5	Fixed altitude and Heading lock flight Mode	● ●		●
6	Auto Circling Mode	● ● ● ●		●
7	During the gyro reset	○	Flash white light for almost one second	
8	Set Servo opposition success	●	After success setting, flash yellow lights for almost one second	
9	too much vibration	●	red light Stay on solid	

11. Vibration damping

- A. DoS is vibration-sensitive. To optimize its stabilization capability, vibrations reaching the unit must be kept at a minimum.
- B. When installing this flight stabilizer, we highly recommend that you install it with the supplied vibration absorbing pads (dampers).
- C. The algorithm in the DoS compensates for normal levels of flight vibration. However, if the vibration experienced by the unit exceeds the acceptable level, it will not work normally or may even stop working altogether.
- D. To keep vibration at a minimum, install the DoS away from the engine or any other vibration sources.
- E. The included shock-absorbing pads will meet the damping requirements for electric powered aircrafts and most gas / nitro planes.
- F. The DoS is supplied with the double-sided foam padding dampers.



Checking for Vibration Levels

Even with the shock absorbing mount, your aircraft installation may not meet the damping requirements of the FSS. To confirm correct vibration damping, please follow this procedure:

- A. After connecting all wires between the DoS ,RC Receiver and ESC, install the unit as recommended (ensure correct orientation).
- B. Run the plane engine or motor at different throttle levels. **DO NOT TAKE OFF.**
- C. Move the throttle level to different positions and maintain it for 20 seconds at each position. At each throttle position, observe the state of the purple LED light. If it stays **OFF**, that means your vibration level is acceptable.
- D. If instead the red LED lights up bright and stays ON solid, then the vibration dampening is not enough. You will need reduce the level of vibration on your aircraft, add additional dampening support or change the installation location.

Too much vibration may cause abnormal condition

1. In the stabilized mode, the plane can't keep steady, may roll or pitch or other abnormal conditions.
2. Under the stabilized mode, after flying a while, it will deviate the steady position, can't keep steady flying.
3. All the navigation modes with GPS can't work normally.

12. Switch channel setting

DoS needs two 3 way-switches to control flying: SW1 is used to set manual mode, stabilized mode, and 3D mode. SW2 is used to set Auto Return To Launch Mode mode, Fixed altitude and Heading lock flight Mode and Auto Circling Mode, which can be set by DoS setting software. SW2 had priority to SW1, only when SW2 switch to cancel (Null) position, the SW1 can work.

After setting, operator can ensure if it is correct by judging the color and flashing situation of the indicator lights.



SW1 default setting state

position	1	2	3
servo signal output	900 ~ 1200US	1200~1800US	1800~2100US
function	manual mode	stabilized mode	3D mode

SW2 default setting state (other function can be set to the SW2 by DoS setting software)

position	1	2	3
servo signal output	900 ~ 1200US	1200~1800US	1800~2100US
function	Fixed altitude and Heading lock flight Mode	NULL	Auto Return To Launch Mode

13. DoS installation Orientation

DoS support 4 installation Orientations(LOGO arrow to up, down left,right) default installation Orientation is the level position, the side with logo is to up, the arrow in the logo is in the same orientation with the head of the plane. If need change other installation orientation,you can through our DoS setting software.

Default installation Orientation:

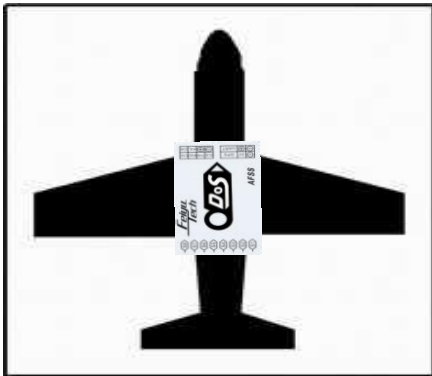

DoS's position

- a) The DoS has an arrow printed on the top of it. Orientate the arrow towards the front of the craft (i.e. direction of flight).
- b) When installing, please keep the DoS horizontal and as close as possible to the "Centre of gravity" (COG) of the aircraft. (as the following diagram.)
- c) Also should keep the DoS in the horizontal level when the plane steady and straight flight,especially for the plane with attack horn.it will be better to bed hedgehopping of its back to keep it in a horizon level.

It may happen the following deviation problems if the installation has deviation. If it has a little deviation, operator can leveling the plane by adjusted Remote Control stick under the stabilized mode.

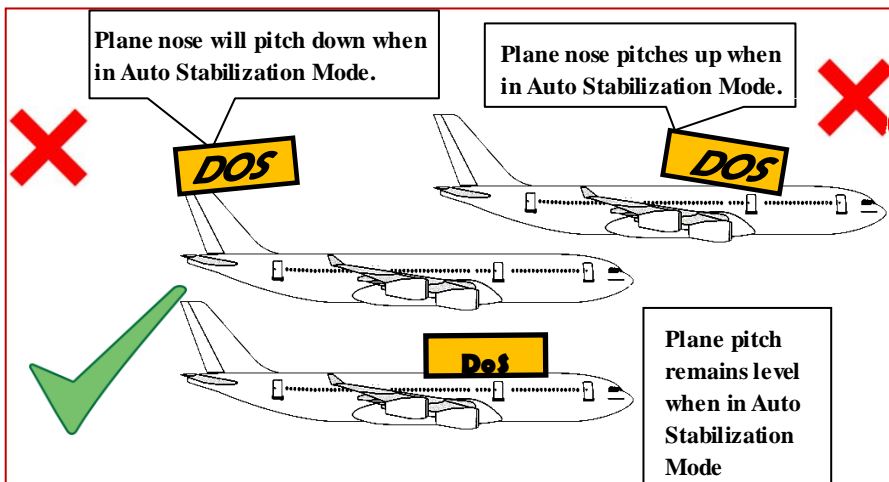
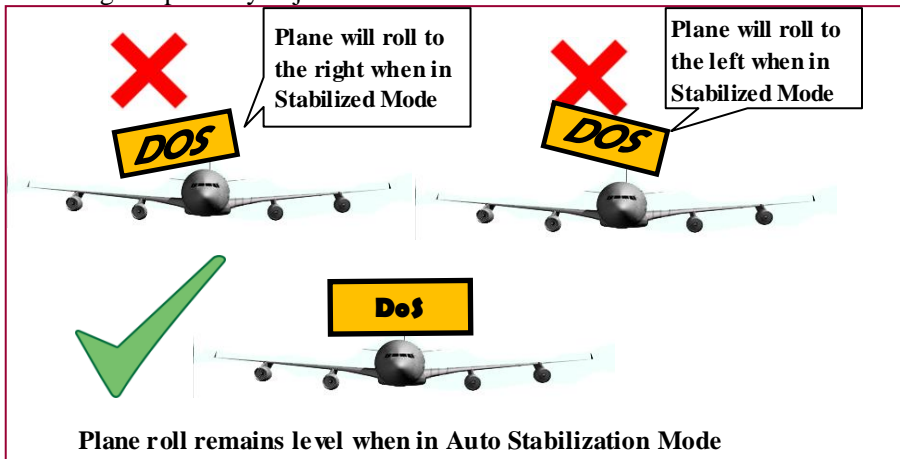

14. Servo surface reverse setting

Servo surface reverse setting through the remote control

after connecting the servo and RC receiver ,first test the remote control movement of servo surface.check whether remote control direction and the corresponding servo surface movement direction is consistent through the remote stick, if not consistent, need to adjust the servos surface reverse setting through the remote control .After adjusting every servo surface you can automatic control the servo surface reverse detection and Settings.

Automatic control Servo surface reverse setting

A. Switch to the stabilized mode

B. Aileron CONTROL SURFACE MOVEMENT CHECK

●Roll the plane to see the following action:Incline the plane to the right (roll right). The ailerons should give a control signal to counter this roll direction (see below). Same as when rolled to the left. If the ailerons move correctly,then you don't need to do the reverse.

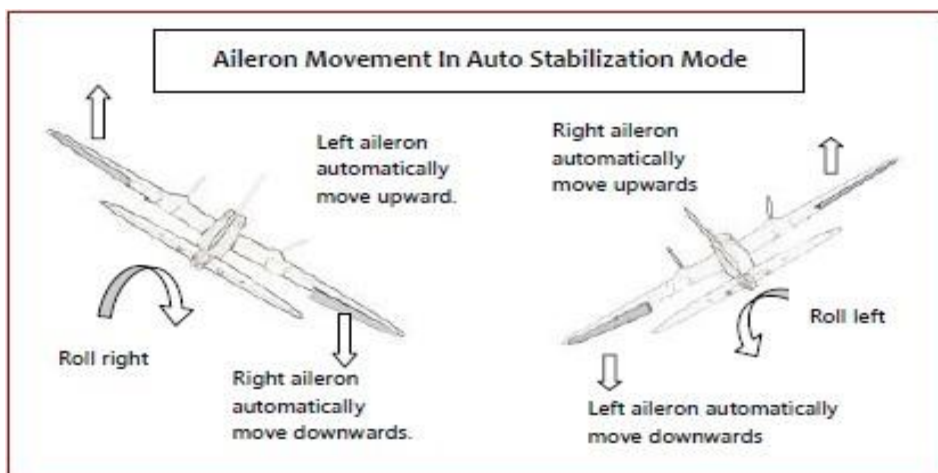

●If the servo movement is incorrect, you can choose one of these ways to change the control movement as follows:

1)Adjust it by using DoS setup software through a USB cable.

2)Roll aileron stick on either side of the maximum position of the remote control. On SW1 switch ABM to 3D mode 6 times, time interval has to be less than 3 seconds as follows:

ABM→3DMode→ABM→3DMode→ABM→3DMode→ABM→3DMode→ABM→3D Mode→ABM→3D Mode, there is a yellow lamp will light up once, it's done.

C. ELEVATOR CONTROL SURFACE MOVEMENT CHECK

●Pitch the plane nose up and down to see the following elevator action:Incline the plane NOSE UP. You should see the elevator move down. And when you move the NOSE DOWN, the elevator should move up.If it's correct, you don't need adjust setting.

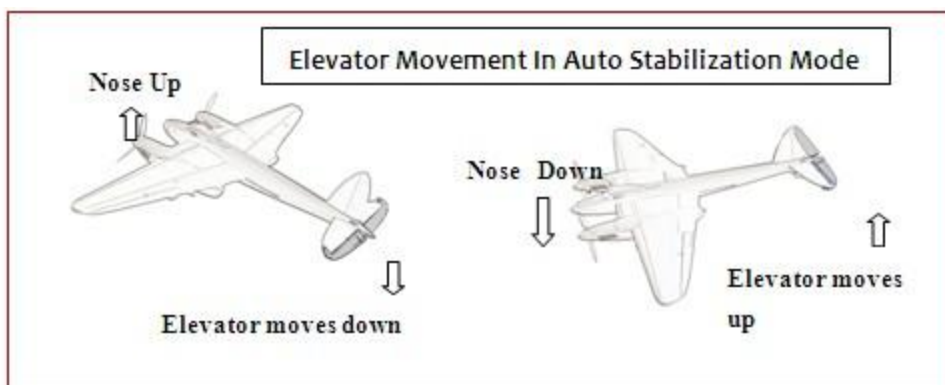

●If the servo movement is incorrect, you can choose one of these ways to change the control movement as follows:

1)Adjust it by using DoS setup software through a USB cable.

2)Roll elevator stick on either side of the maximum position of the remote control. On SW1 switch ABM to 3D mode 6 times, time interval has to be less than 3 seconds as follows:

ABM→3DMode→ABM→3DMode→ABM→3DMode→ABM→3DMode→ABM→3D Mode→ABM→3D Mode, there is a yellow lamp will light up once, it's done.

D. RUDDER CONTROL SURFACE MOVEMENT CHECK

●Turn your plane clockwise or counter clockwise to see the rudder movement below:

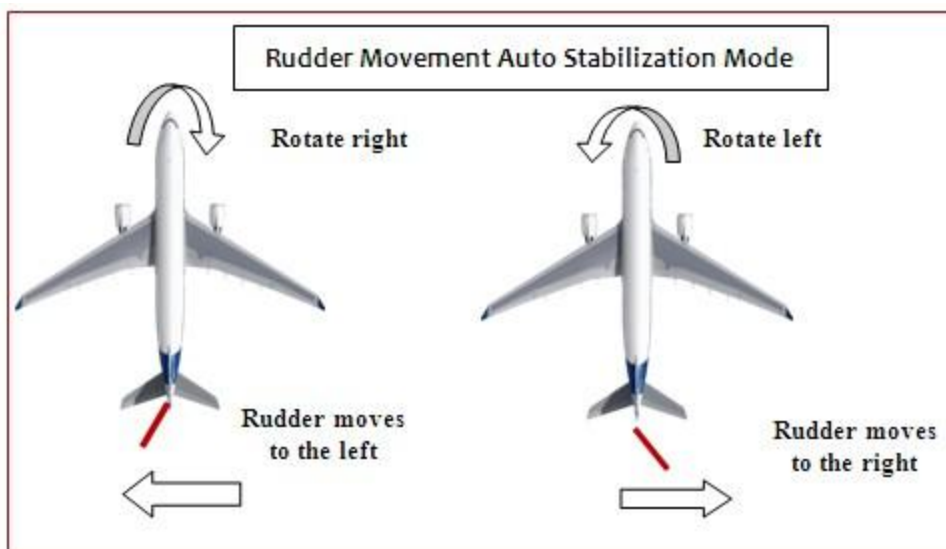

●If the servo movement is incorrect, you can choose one of these ways to change the control movement as follows:

1)Adjust it by using DoS setup software through a USB cable.

2)Roll rudder stick on either side of the maximum position of the remote control. On SW1 switch ABM to 3D mode 6 times, time interval has to be less than 3 seconds as follows:

ABM→3DMode→ABM→3DMode→ABM→3DMode→ABM→3DMode→ABM→3D Mode→ABM→3D Mode, there is a yellow lamp will light up once, it's done.

E. ESC/ THROTTLE CONTROL SURFACE MOVEMENT CHECK

ESC/throttle can be set by DoS setting software or RC controller. First, adjust throttle's control movement on RC controller, roll throttle stick on lowest position, then on SW1, switch ABM to 3D mode 6 times, time interval has to be less than 3 seconds as follows:

ABM→3DMode→ABM→3DMode→ABM→3DMode→ABM→3DMode→ABM→3D Mode→ABM→3D Mode, there is a yellow lamp will light up once, it's done.

15. Gyroscope Reset

If the following conditions occur, the DoS initialization is recommended:

- (1) The device has not been used for a long time.
- (2) There is a change in environmental temperature of over 30 degrees since last flight.
- (3) The purple LED flashes continuously even when the DoS remains stationary and you never activate the motor.

Note:

●Carry out this re-setting procedure only if the above occur. We do not recommend regular re-setting. It is not necessary and not recommended.

●The stabilizer unit does not need to be in a horizontal position during initialization. However, you must ensure there is no vibration during this process. If suspect shaking occurred during the procedure, just restart the initialization / resetting process.

Initialization / Reset Process:

- 1, power on and keep stationary.
- 2, switch to ABM.
- 3, On SW1, switch ABM to Deactivated Mode 6 times, time interval has to be less than 3 seconds as follows:
ABM → Deactivated Mode → ABM → Deactivated Mode → ABM → Deactivated Mode → ABM → Deactivated Mode → ABM → Deactivated Mode.
- 4, DoS indicator will flash white about one second.
- 5, After white lamp lights off, the re-setting / initialization is complete.
(If you connect a DoS setup software, you can initialize it by click "Init GYRO" button.)

16. DoS Setting Software:

connection mode:

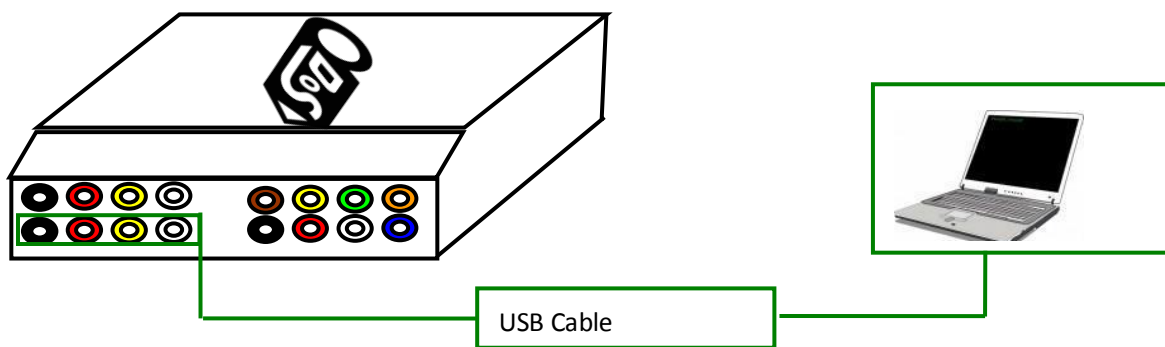

First need install USB-TTL device driver, you can download it form our website: www.feiyudz.cn
Software Interface Description:(Parameter in the following picture is default parameter)

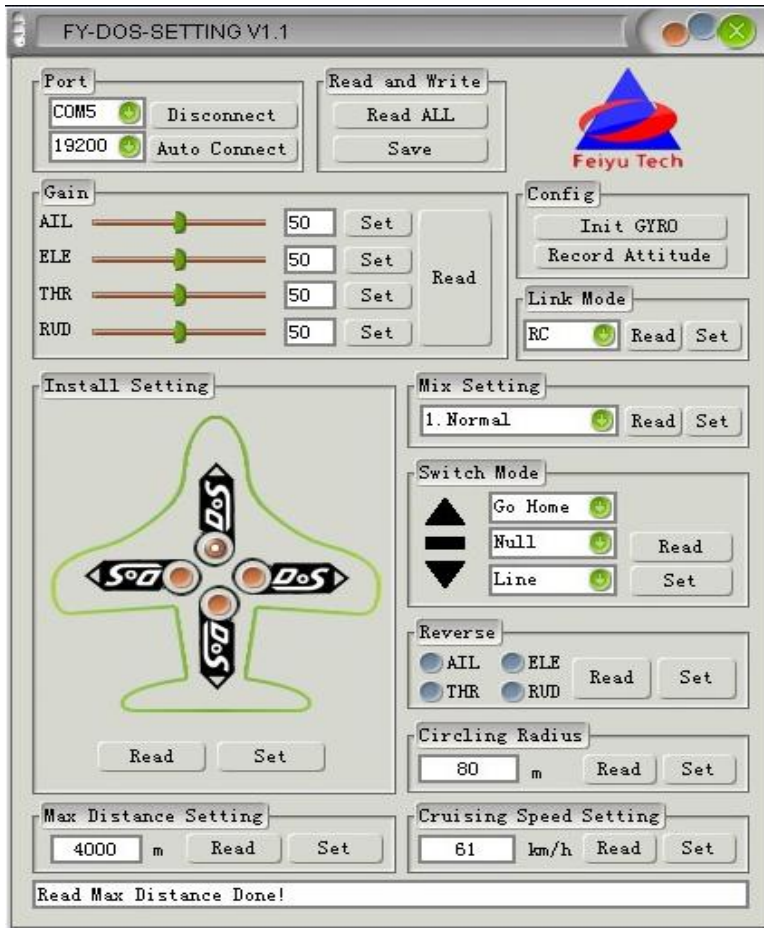

“Port” Connection columns :

Connect DoS to your PC, from “my computer” –“device manager” –“Port” to find COM port , select corresponding COM port. Baud rate has to be “19200”, click “connect”button. Or just click “Auto Connect” button, it will search automatically,but it’s takes time. Note: only after this has been done, then you can set other settings.

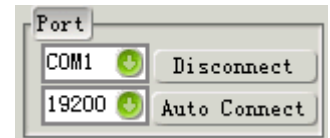

“Read and Write”window:

Click “Read All” to read all default parameters.
Click “Save” to save all record to flash.

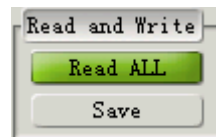

“Gain” window:

It’s for servo control movement Gain, Set Range:0-100,if gain number is getting higher, DoS will be getting more sensitivity.

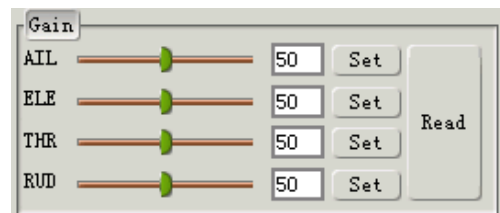

“Config” Configuration window :

Click “Init GRYO” to gyro reset. And our software status bar will prompt initial success. Don’t use it during flying!
Record Attitude:

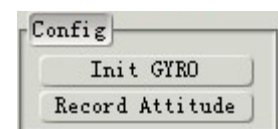

This function is mainly used to eliminate the installation attitude angle and aircraft level flight attitude angle deviation. DoS default benchmark angle is o degrees. It’s not necessary to adjust. If you want to adjust more accurate, as follows:

Install DoS on airplane, after setting direction, placed the airplane into level flight attitude, use this function to record the current attitude which is the basic attitude in ABM.

If DoS is connected with Data Radio, it can be used in flying. Keep airplane level flight, click it to finish the record attitude.

“Link Mode”setting window:

“RC” (default) choose RC receiver control.

“RADIO”choose Data Radio and Remote Adaptor control(for details, please see Remote Adaptor and Data Radio instructions).

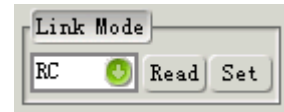

“Install Setting”setting window:



- DoS support four install direction. Front which has LOGO must be installed facing up.
- DoS has an arrow printed on the top of it. Normally Orientate the arrow towards the front of the craft.
- If you adjust the installation direction, it has to be set in software, otherwise you couldn't use DoS to realize automatic pilot.

“Mix Setting”

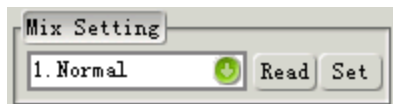

Choose the correct mixing mode,otherwise it will cause aircraft doesn't work normally.

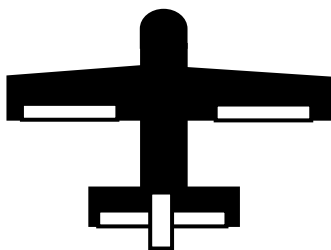

traditional

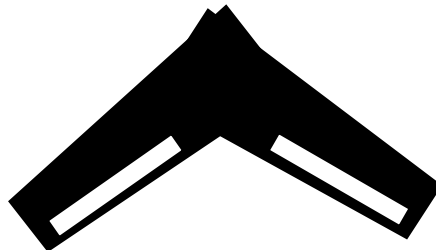

flying wing

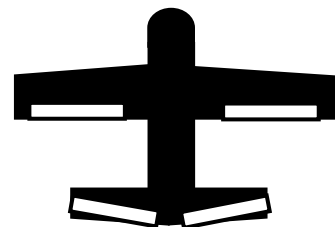

V tail

Models selection table:

Aircraft Layout	Mix Setting	Remark
Traditional aircraft layout with Aileron	1.Normal	Navigation control with aileron
	4.Normal (RUD NAV)	Navigation control with rudder

Flying wing aircraft	2.Elevons	Navigation control with aileron, it can be used for all kinds of flying wing plane
	5.Elevons (RUD NAV)	Navigation control with rudder, only can be used for one that has separate rudder
V tail aircraft with Aileron	3.V-Tail	Navigation control with aileron
	6.V-Tail (RUD NAV)	Navigation control with rudder, only can be used for V-tail plane that has separate rudder
Traditional layout aircraft with no Aileron	1.Normal	The rudder has to connect to DoS aileron servo output position (AIL)
V tail aircraft without ailerons	2.Elevons	V tail aircraft servo has to connect with position of differential servo 1 and 2
Airship	4.Normal (RUD NAV)	Need more test flights, please use it with caution.

“Switch Mode”SW2 function settings window:

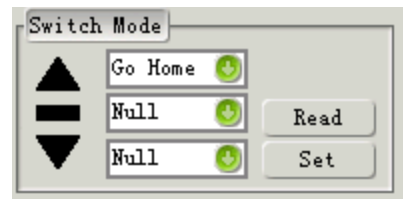
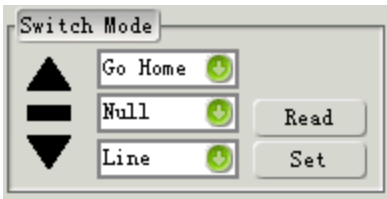

Usually, we need a 3-position switch (named as “SW2”) to switch the navigation mode, you can set different functions by software in sw2.

Note: SW2 is priority than SW1, only when SW2 is in "Null" mode, then SW1 can work. so, we have to set a NULL, otherwise SW1 doesn't work. We recommend SW2 middle position is set to Null, both sides can be set the navigation mode which you like.

SW2 is a 2-position switch.

We recommend to set it as the right picture of above, the “middle” and the “down” position is set to null, the “up” position is used to select the navigation mode you like.

navigation mode:

Name	Function	Remark
Null	Deactivated Mode	SW2 set to NULL, flying mode is in sw 1
Go Home	Auto Return To Launch Mode	Automatically return to launch point.
Line	Fixed altitude and Heading lock flight Mode	After release the operating stick, it will lock heading and altitude.
Circle	Auto Circling Mode	Automatically around a fixed point flying.

“Reverse”-Automatic control servo surface reverse window:

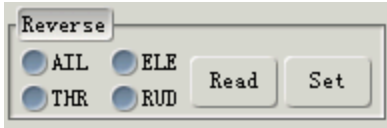

It is for modify the control direction. Control direction's check and adjust please see point 14.

“Circling Radius” settings window:

It is for adjusting the circling radius on Auto Circling Mode. Units is meters, the default setting is 80 meters.

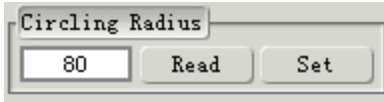

State prompted dialog box, used for indicating send or receive instruction state, etc



17. Connection between DoS and Hornet-OSD

Hornet-OSD can be used to connect to the DoS 's UART interface, or after upgrade Hornet-OSD to version V1.6, with a Y-type data cable ,you can connect Hornet-OSD and the GPS module to the DoS's GPS port to obtain high data refresh rate, make OSD data display more real-time. The connection diagram is as follows. Under the version of V1.6 , OSD only can be connected to the DoS 's UART interface.

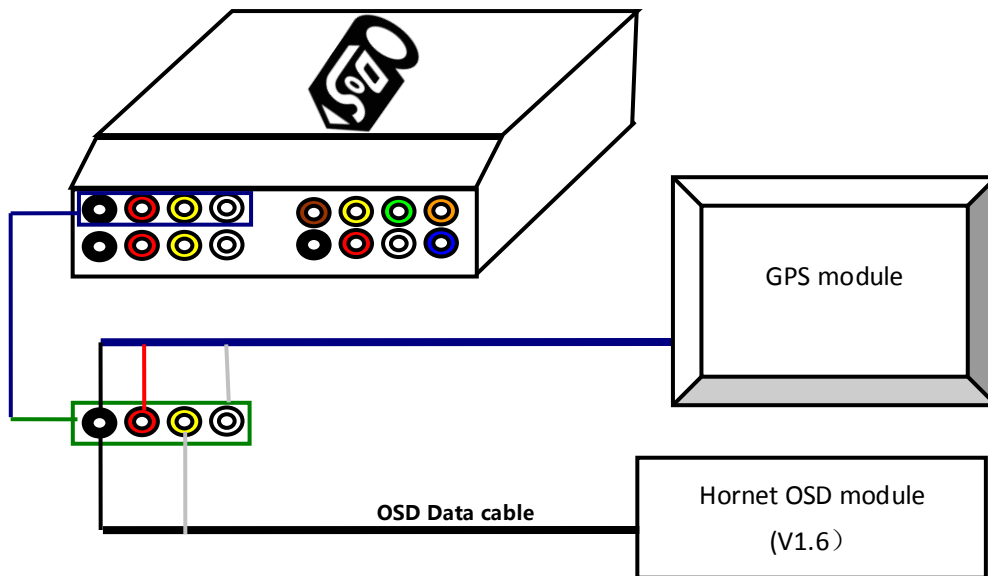

Note: More information please login: www.feiyudz.cn

18. Data Radio and GCS software

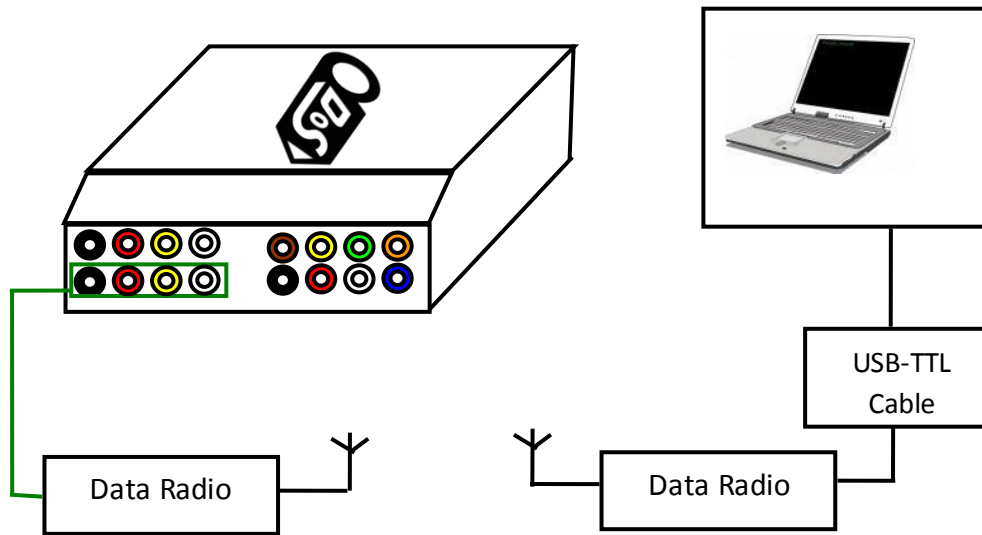

Data radio baud rate: 19200

DoS can set parameters, and monitoring of flight data by data radio. GCS software can (www.feiyudz.cn) monitor the flight altitude, speed, path data. Can use the Remote Adapter (for details please see the relevant instructions for use of the Remote Adapter), through Data Radio to remote control aircraft.

19. Influence of remote control servo movement and automatic control servo movement

In any mode, RC can interfere with the aircraft's control, automatic control movement in the DoS is superimposed on the amount of manual control and output to the servos. So in ABM, you will feel the aircraft operate is less flexible, which is normal. Adjust suitable feel by "Gain". The greater the gain is, the stronger balance force is and the smaller manual remote control effect is, the smaller the gain is, the weaker balance force is, the greater manual remote control effect is.

In navigation mode, for example, Auto Return To Launch (RTL), Auto Circling Mode (ACM), let the RC control stick on the middle, at this moment you would be interfered by automatic control movement, the aircraft may lose control.

20. "Fail-Safe" setting

In RC mode, need the RC and RC receiver both must have "Fail-Safe" function. First of all, SW2 switch setting into can use "Return To Launch (RTL)" mode. Then, through RC set RC receiver "Fail-Safe" protection, when RC out of control, the SW2 signal will switch to "Return To Launch (RTL)" position. Pay attention to set the throttle control stick to the cruise throttle position, or you will have the danger of stall.

In DRRC mode, because the use of Remote Adaptor, will automatically detect radio communication is normal or not, if the communication interrupt, after about 5 seconds will automatic into "Return To Launch (RTL)" mode.

The firmware of the DoS above version V1.1, at "RC remote control Mode" increased max distance flight setting. At "RC remote control mode", if the plane distance from home point more than the "Max Distance Setting" which you set, the DoS will automatically into Auto Return To Launch Mode (RTH), in order to prevent aircraft fly lost situation due to no "Fail-Safe" setting of the Remote Controller. DoS default flight max distance is 4000 meters. Also at "RC remote control mode", increased the judgment of RC receiver and DOS connectivity, if they all disconnect, the DoS will automatic into Auto Return To Launch Mode (RTH).

"Max Distance Setting" settings window :

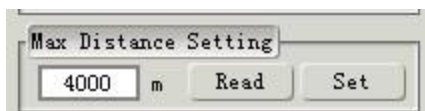

21. Cruising Speed Setting

DoS in navigation mode is participate in throttle control, throttle control quantity will stack in the output of RC throttle stick , as far as possible to control the plane in accordance with the cruising speed flight, cruising speed should be set as the plane normal flat fly speed value, the unit is km per hour and the default cruising speed of DoS is 61 km/h.

“Cruising Speed Setting” settings window :

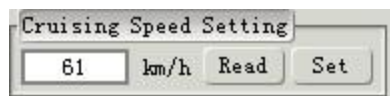

22. DoS flight test

- 1) According to the manual properly connected each module, pay attention to DoS module Vibration damping installation.
- 2) Check the DoS installation direction.
- 3) Connect the power, check SW1 switch, and SW2 switch, through the indicator light check each mode can normally switch or not.
- 4) Switch DoS to " Stabilized Mode ", reference manual 14 point. Check the control surface movements is correct or not, if is not correct, you must not take off, it is necessary to adjust it to be right. At the same time observe the quantity of automatic control output and estimate is appropriate or not, the first test flight, unfavorable to use too much sensitivity. So you should after the flight look at the situation to adjust gradually.
- 5) The plane placed in the stationary state (can not be observed any rock), SW2 in Deactivated Mode (Null) to see if there is purple light flashing, if there is, then need to gyro initialization (reference manual 15 point).
- 6) Check the influence of vibration on DoS (reference manual 11 point)
- 7) After completion the check, you can take off now, manual adjust the plane then switch to Stabilized Mode, observe the flight state (also you can directly in the Stabilized Mode to take off).
- 8) Through the RC stick to trim the plane to level fly. Manually to change the plane roll and pitch, etc., to observe the plane automatic balance situation. If recover to balance is too quick, don't feel flexible operation you can reduce corresponding channel control gain (adjust control gain, you need to land the aircraft, and use DoS setting software to adjust); If the pitch, roll and orientation rapid shaking, or flight speed increases appear sloshing, you need reduce corresponding control channel gain; If recover to balance is too slow, the poor control ability is require you to increase control gain.
- 9) Sensitivity gain adjustment need multiple flights to test, all kinds of aircraft flight characteristics is different, so the use of control gain can also be different
- 10) After test well the stabilized mode, please keep the throttle at the cruising position , then switch the SW2 to Return To Launch Mode (RTL), then the plane should return to the home point, and circle after it reach the home point. If this test successfully, then you can switch to the stabilized mode fly the plane to a farther distance to test the RTL again.

Note: We reserve the right to change this manual at any time! And the newest edition will be shown on our website.

-----END-----